



# Handrail



# And

# Fence

Dolphin Metal Products Co., LTD

Email: [sales@fsdolphin.com](mailto:sales@fsdolphin.com)

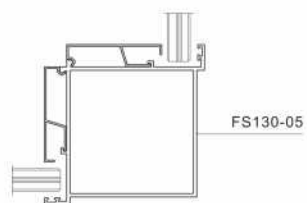
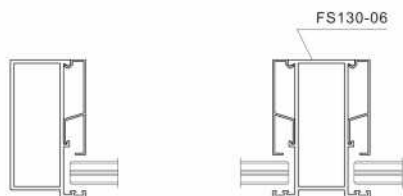
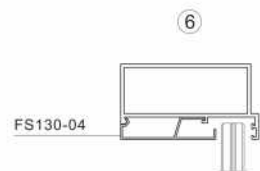
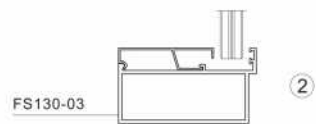
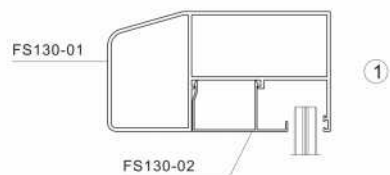
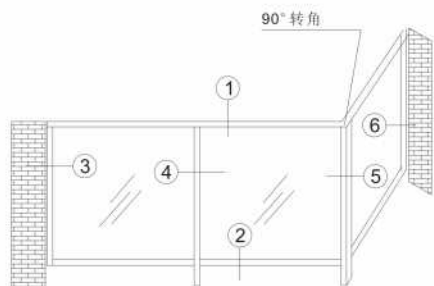

③





④

⑤

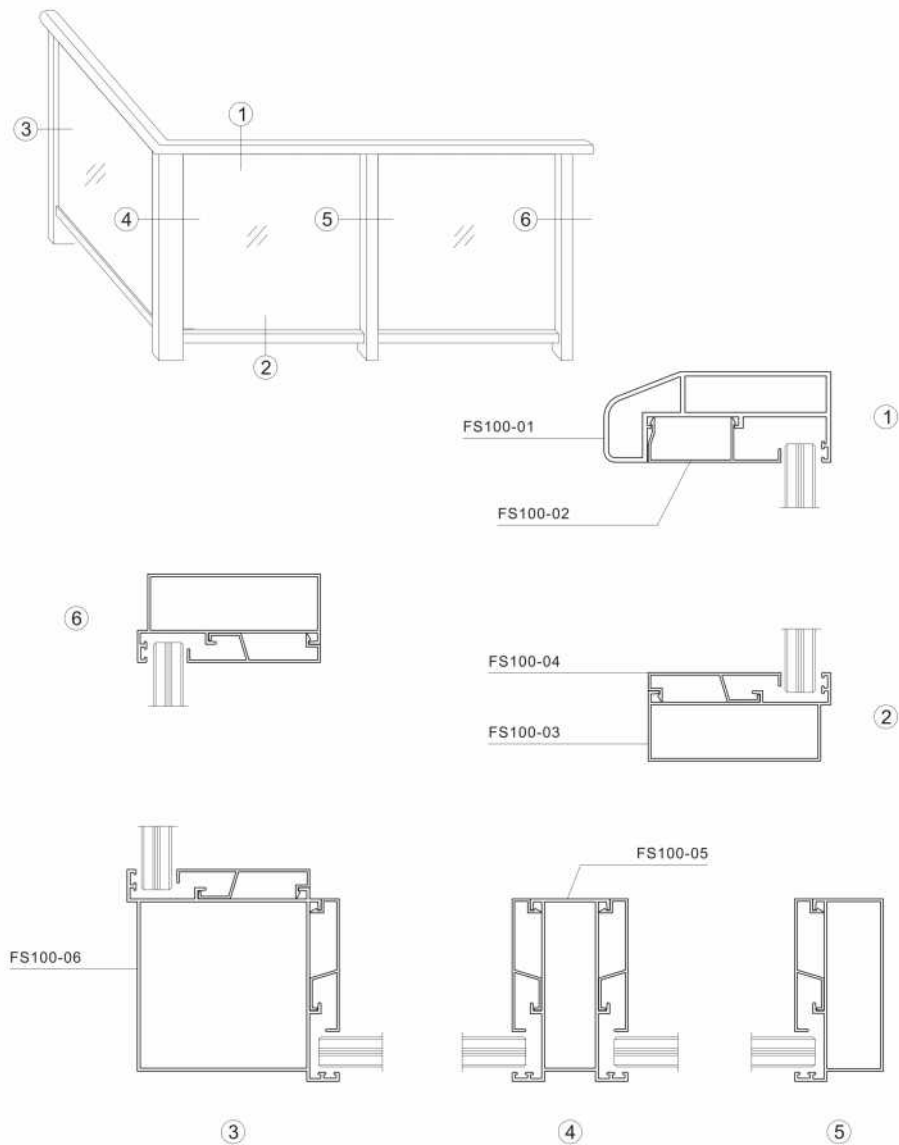
产品编号	产品图例	用途	产品编号	产品图例	用途
FS130-01 T=2.0mm 2.470kg/m 配: FS130-02		扶手	FS130-02 T=1.0mm 0.320kg/m		压线
FS130-03 T=2.0mm 1.280kg/m 配: FS130-04		边固框	FS130-04 T=1.0mm 0.280kg/m		压线
FS130-05 T=2.0mm 1.930kg/m 配: FS130-04		90° 转角	FS130-06 T=2.0mm 1.440kg/m		立柱
FS130-01A T=2.0mm 2.090kg/m 配: FS130-02		扶手	FS130-02A T=1.0mm 0.330kg/m		压线
FS130-04A T=1.0mm 0.280kg/m		压线	FS130-07 T=2.0mm 1.987kg/m		转角

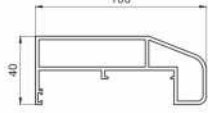

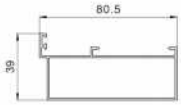

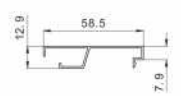
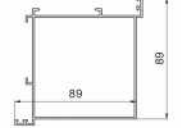
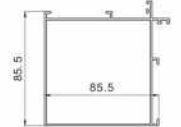
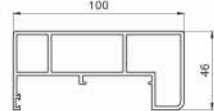
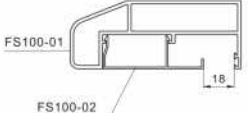

产品编号	产品图例	用途	产品编号	产品图例	用途
FS100-01 T=2.0mm 1.654kg/m 配压线: FS100-02		扶手	FS100-02 T=1.05mm 0.292kg/m		压线
FS100-03 T=1.2mm 0.798kg/m		横杆	FS100-05 T=1.3mm 0.997kg/m		立柱
FS100-04 T=1.05mm 0.310kg/m		压线	FS100-06 T=1.3mm 1.360kg/m		转角
FS100-07 T=1.3mm 1.390kg/m		转角	FS100-08 T=2.0mm 1.939kg/m 配压线: FS100-02		扶手
					

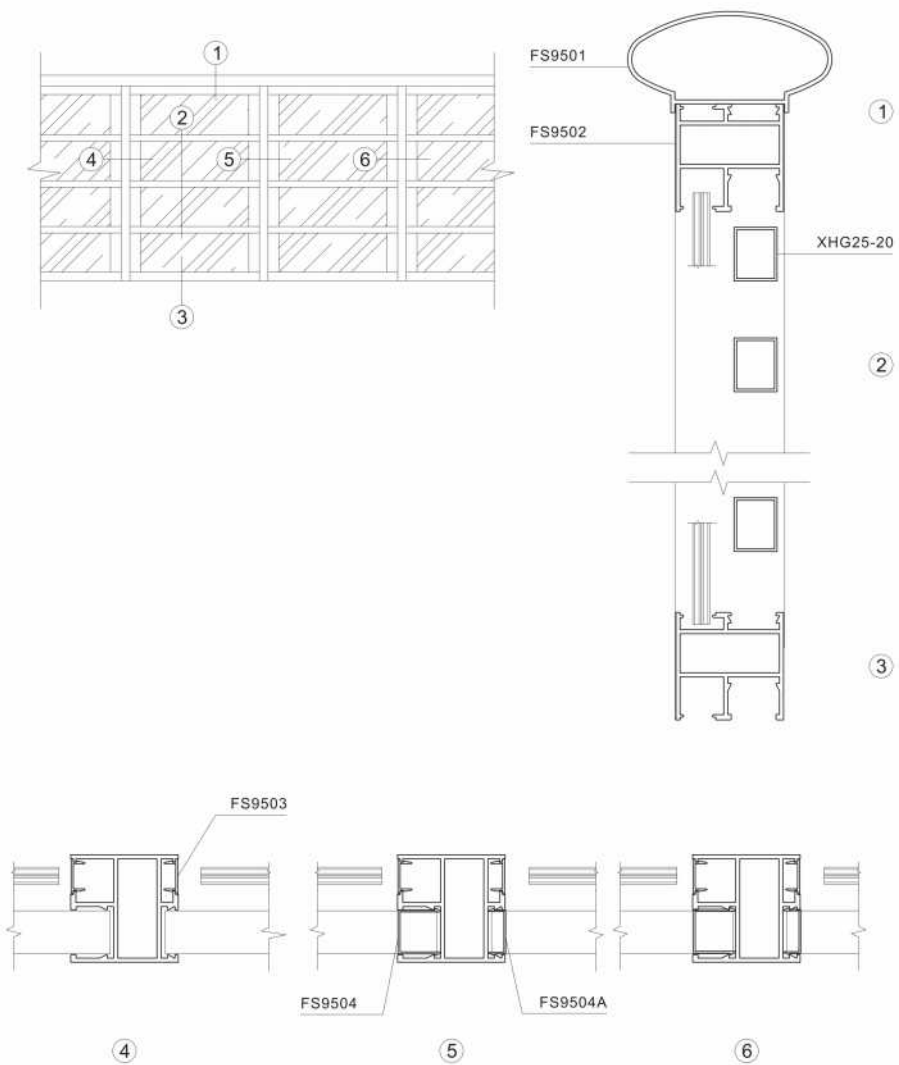

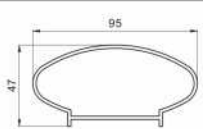
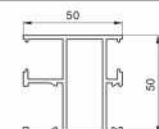
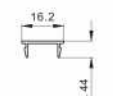
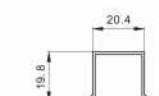
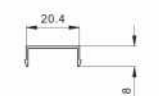

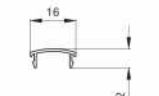
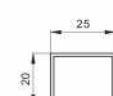
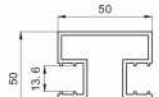
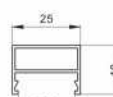
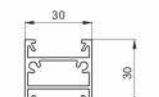
产品编号	产品图例	用途	产品编号	产品图例	用途
FS9501 T=1.9mm 1.203kg/m		扶手	FS9502 T=1.9mm 1.272kg/m		立柱
FS9503 T=1.0mm 0.069kg/m		封口盖	FS9504 T=0.9mm 0.152kg/m		封口盖
FS9504A T=0.8mm 0.075kg/m		封口盖	FS9505 T=1.9mm 1.032kg/m		中横
FS9506 T=0.9mm 0.065kg/m		封口盖	XHG25-20 T=1.2mm 0.278kg/m		栅格
FS9507 T=1.9mm 1.313kg/m 配: FS9503		立柱	FS9508A T=1.0mm 0.239kg/m 配: FS9504A		立柱
FS9510A T=1.3mm 0.596kg/m		横杆			



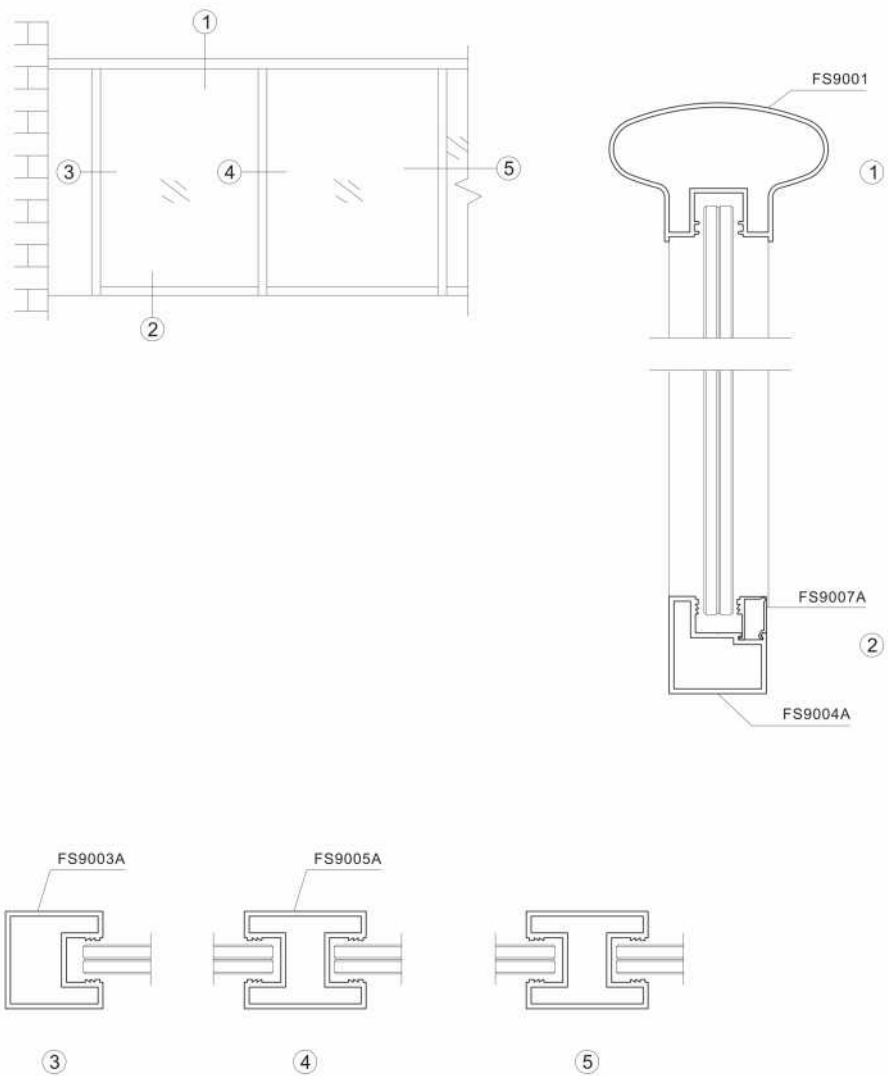

产品编号	产品图例	用途	产品编号	产品图例	用途
FS9001 T=1.8mm 1.408kg/m 配: FS9008		扶手	FS9002 T=2.0mm 1.476kg/m		扶手
FS9009 T=2.0mm 1.412kg/m		扶手	FS9003A T=2.0mm 1.016kg/m		立柱
FS9003P T=1.5mm 0.859kg/m 配: FS9008A		立柱	FS9005A T=2.0mm 1.315kg/m 配: FS9008A		立柱
FS9004A T=2.0mm 0.858kg/m 配压线: FS9007A		横杆	FS9007A T=1.0mm 0.151kg/m		压线
FS9006 T=1.8mm 1.325kg/m 配: FS9008		90° 转角	FS9005P T=1.5mm 1.008kg/m 配: FS9008A		立柱
FS9008A T=1.0mm 0.080kg/m		盖板	FS9008 T=0.9mm 0.076kg/m		盖板



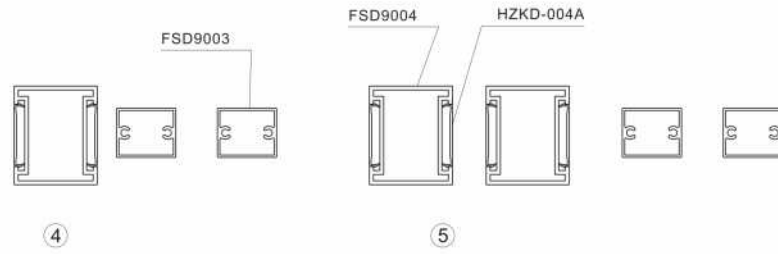
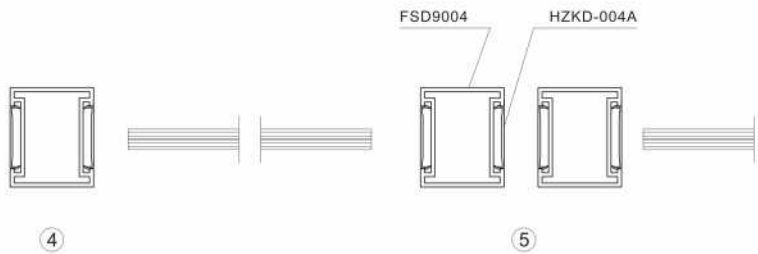
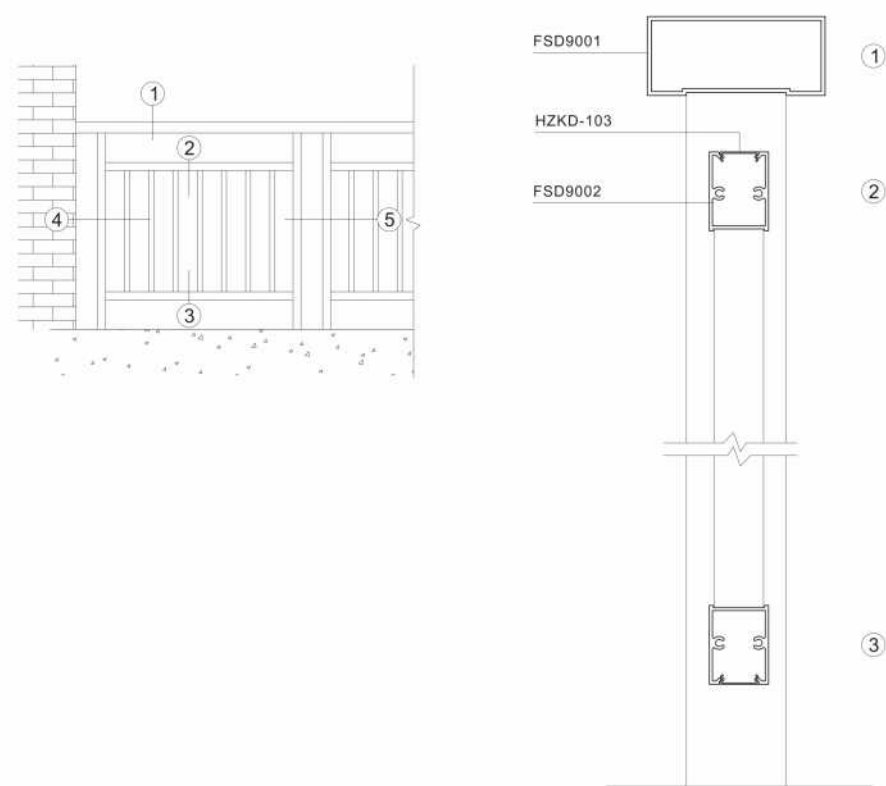
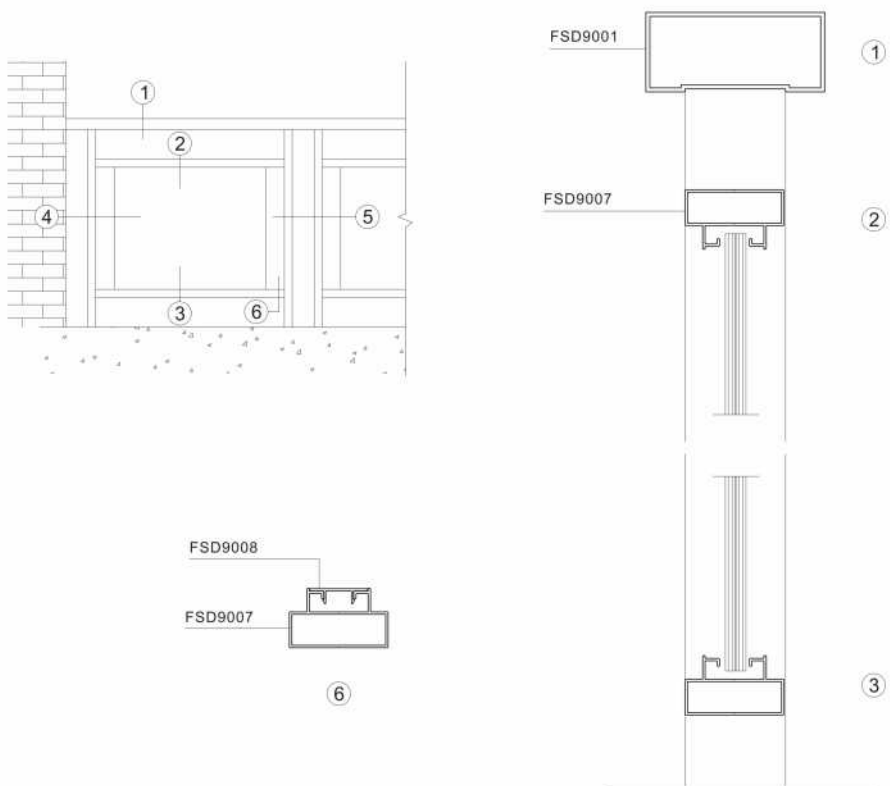

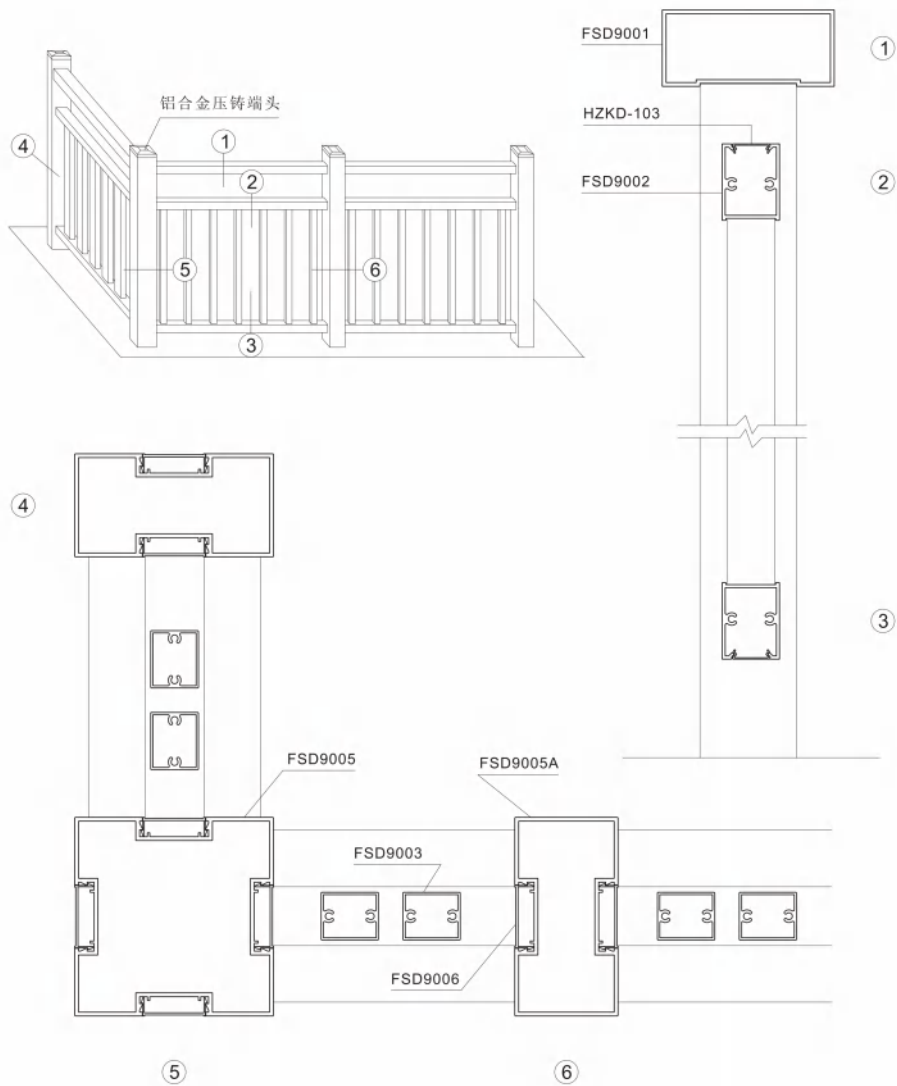





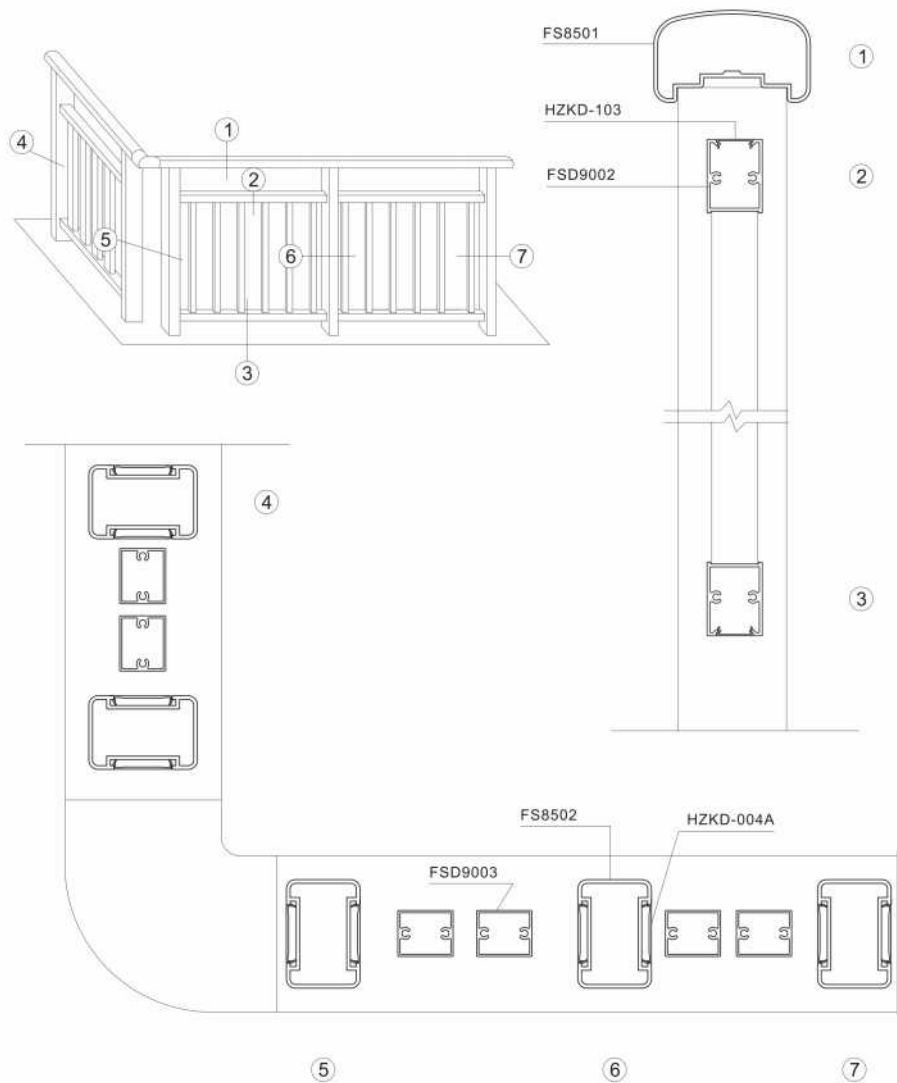

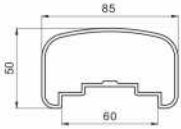
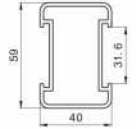
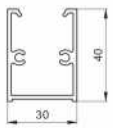
产品编号	产品图例	用途	产品编号	产品图例	用途
FSD9001 T=2.0mm 1.391kg/m		扶手面	FSD9002 T=1.6mm 0.632kg/m 配: HZKD-103		横杆
FSD9003 T=1.2mm 0.449kg/m		格槽	FSD9004 T=2.0mm 1.138kg/m 配: HZKD-004A		立柱
FSD9005 T=2.0mm 2.839kg/m 配: FSD9006 压铸配: Y-(YT05)		转角	FSD9006 T=1.2mm 0.156kg/m		盖板
FSD9007 T=1.2mm 0.570kg/m 配: FSD9008		横杆	FSD9008 T=1.2mm 0.127kg/m		盖板
HZKD-004A T=1.2mm 0.112kg/m		盖板	HZKD-103 T=0.7mm 0.057kg/m		盖板
FSD9005A T=2.0mm 1.993kg/m 配: FSD9006 压铸配: Y-(YT04)		立柱	FSD9002A T=1.4mm 0.550kg/m 配: FSK8010		横杆
简图	编号	材质	用途	备注	
	Y-(YT04)	合金压铸	立柱端盖	配: FSD9005A	
	Y-(YT05)	合金压铸	转角端盖	配: FSD9005	

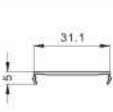



产品编号	产品图例	用途	产品编号	产品图例	用途
FS8501 T=2.0mm 1.473kg/m		扶手	FS8502 T=2.0mm 1.137kg/m 盖板配: HZKD-004A		立柱
FSD9002 T=1.6mm 0.632kg/m 盖板配: HZKD-103		横杆	HZKD-103 T=0.7mm 0.057kg/m		盖板
HZKD-004A T=1.2mm 0.112kg/m		盖板			
简图	编号	材质	用途	备注	
	Y-(YT01)	合金压铸	90度转角弯头	每一个90度转角配一个	
	Y-(YT02)	合金压铸	扶手驳接件		
	Y-(YT03)	合金压铸	扶手端头封盖		





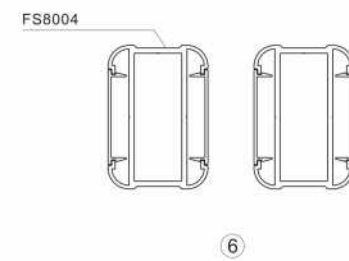
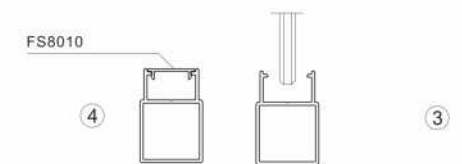
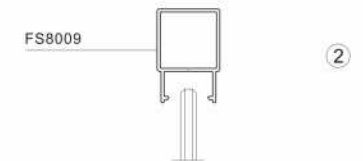
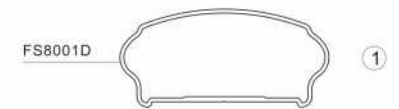
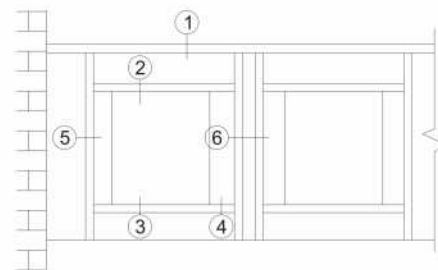
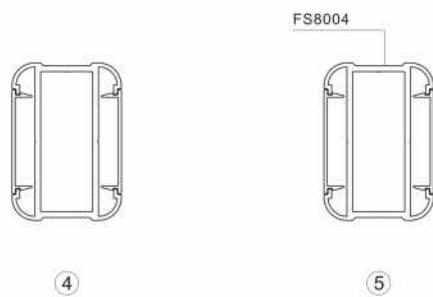
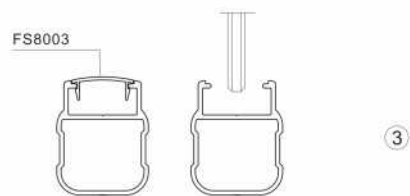
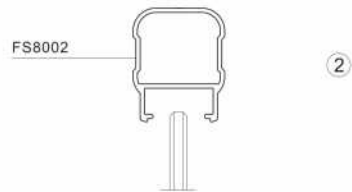
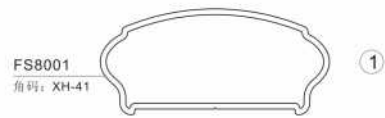
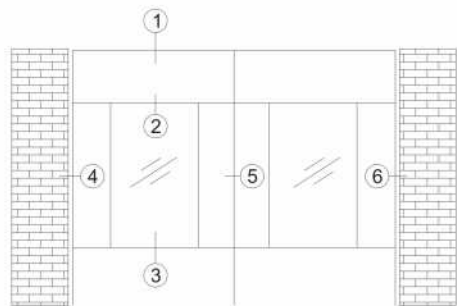

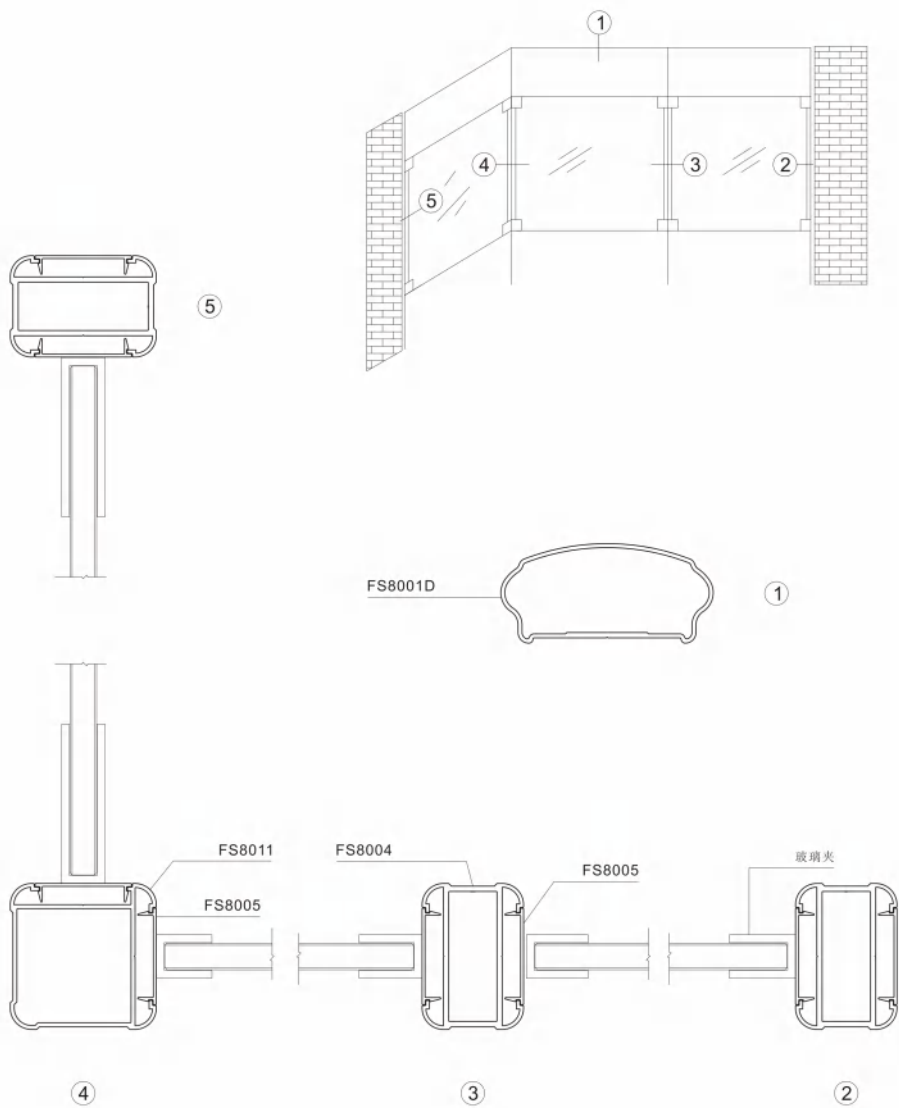

产品编号	产品图例	用途	产品编号	产品图例	用途
FS8001 T=2.0mm 1.064kg/m FS8001P T=1.4mm 0.760kg/m		扶手	FS8002 T=1.5mm 0.647kg/m 配: FS8003 FS8002A T=1.4mm 0.571kg/m 配: FS8003A (玻璃口10)		横杆
FS8003 T=1.1mm 0.094kg/m 配: FS8002		盖板	FS8004 T=2.0mm 1.033kg/m 配: FS8005		立柱
FS8004P T=1.5mm 0.848kg/m 配: FS8005		立柱	FS8005 T=1.1mm 0.140kg/m 配: FS8004 FS8004P		盖板
FS8006 T=1.2mm 0.205kg/m		格栅	FS8007 T=2.0mm 1.478kg/m 配: FS8005		转角
FS8011 T=1.5mm 0.964kg/m 配: FS8005		转角	FS8001D T=1.5mm 0.860kg/m		扶手
FS8009 T=1.2mm 0.385kg/m 配: FS8010		横杆	FS8008 T=1.5mm 1.276kg/m		角码
FS8004AP T=1.4mm 0.740kg/m 配: FS8005		立柱	FS8012 T=1.5mm 0.780kg/m 配: FS8005		立柱
FS8010 T=0.9mm 0.060kg/m		盖板	FS8003A T=1.1mm 0.094kg/m		盖板



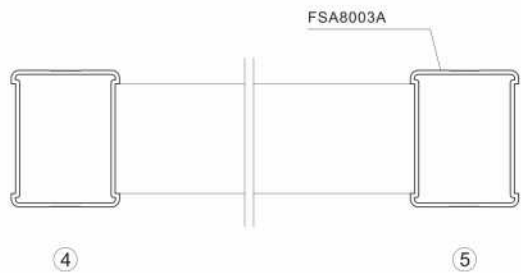
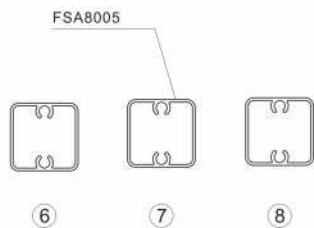
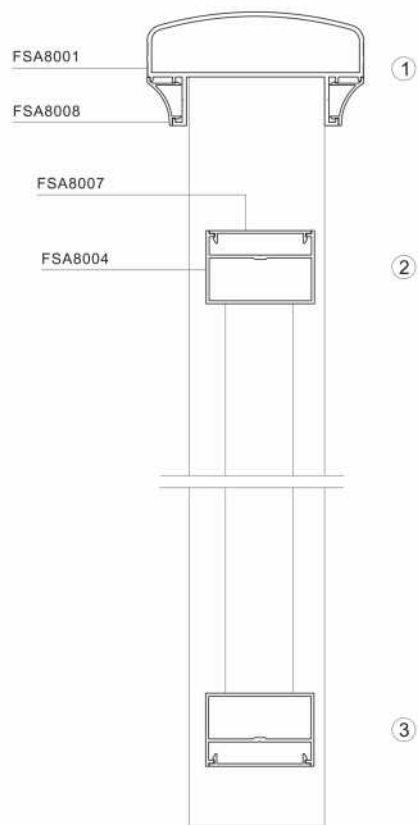
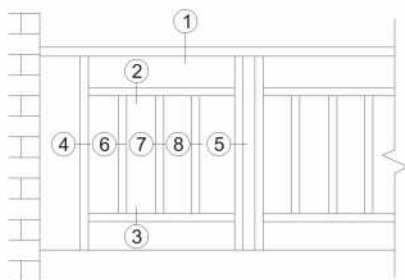

产品编号	产品图例	用途	产品编号	产品图例	用途
FSA8001 T=1.5mm 0.961kg/m		扶手面	FSA8008 T=1.0mm 0.083kg/m		扣条
FSA8004 T=1.1mm 0.405kg/m		横杆	FSA8007 T=1.0mm 0.121kg/m 配: FSA8004		扣板
FSA8005 T=1.0mm 0.312kg/m		格框	FSA8003A T=1.5mm 0.716kg/m		立柱



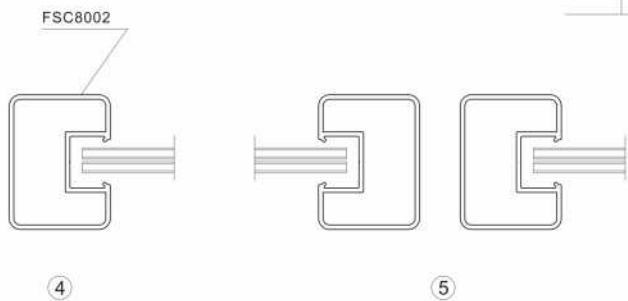
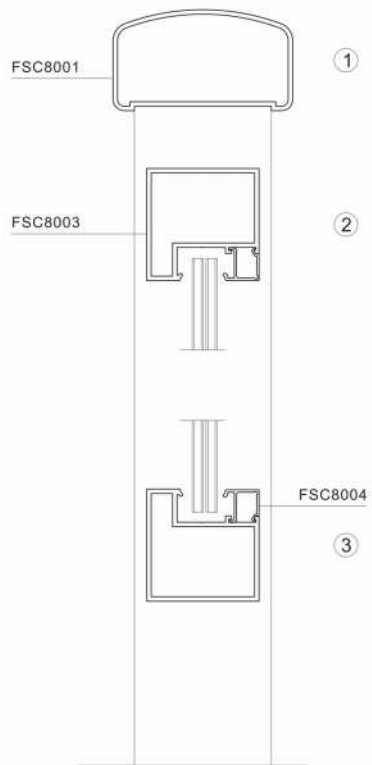
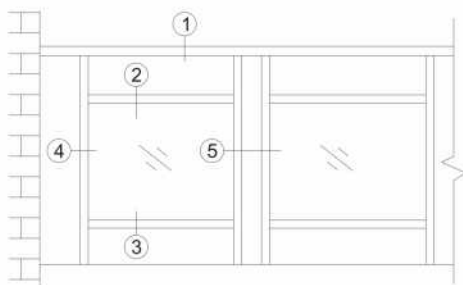



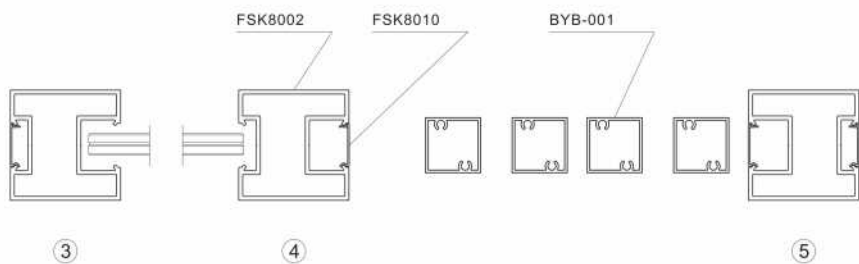
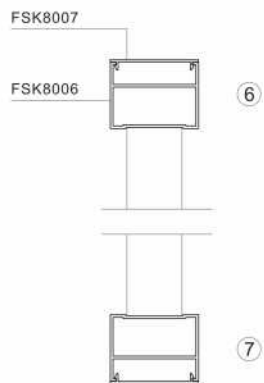
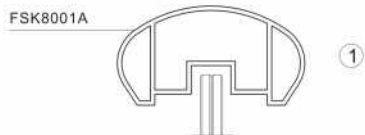
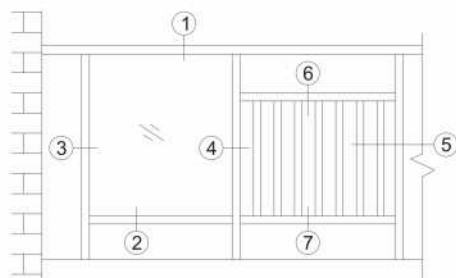

产品编号	产品图例	用途	产品编号	产品图例	用途
FSC8001 T=2.0mm 1.231kg/m		扶手	FSC8002 T=2.0mm 1.291kg/m		立柱
FSC8003 T=2.0mm 1.091kg/m		横杆	FSK8010 T=0.7mm 0.053kg/m		扣盖
FSC8004 T=1.0mm 0.133kg/m		压线	HZKD-004A T=1.2mm 0.112kg/m		扣盖
FSC8003A T=1.5mm 1.000kg/m 配: HZKD-004A		横杆			

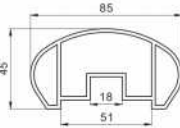
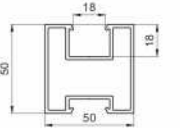

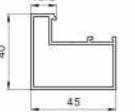

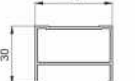
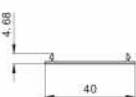
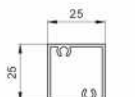
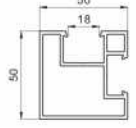
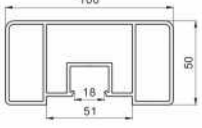
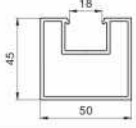
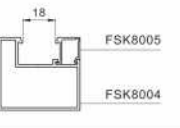
产品编号	产品图例	用途	产品编号	产品图例	用途
FSK8001A T=2.0mm 1.679kg/m		扶手	FSK8002 T=1.8mm 1.261kg/m		立杆
FSK8010 T=0.7mm 0.053kg/m		扣盖	FSK8004 T=1.4mm 0.671kg/m		横杆
FSK8005 T=1.1mm 0.128kg/m		压线	FSK8006 T=1.2mm 0.454kg/m		横杆
FSK8007 T=1.0mm 0.128kg/m		压盖	BYB-001 T=1.2mm 0.365kg/m		格栅
FSK8008 T=1.8mm 1.258kg/m		转角	FSK8009 T=2.0mm 2.294kg/m		扶手
FSK8011 T=1.8mm 1.105kg/m		横杆			



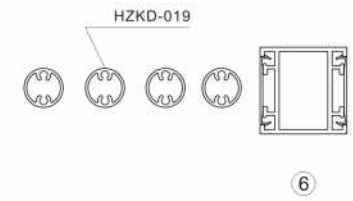
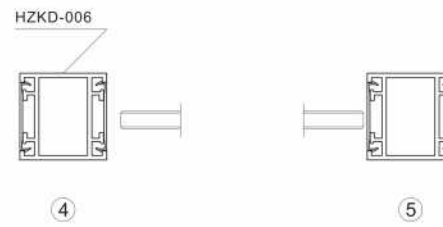
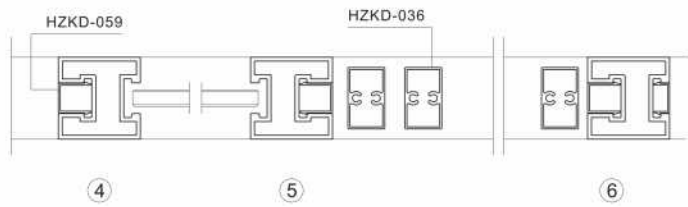
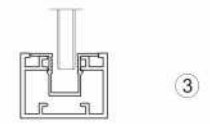
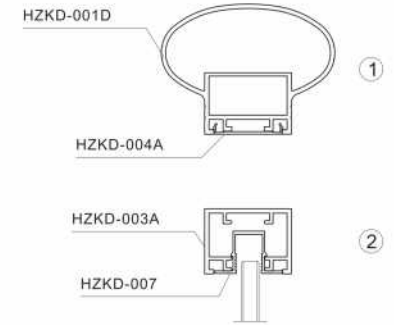
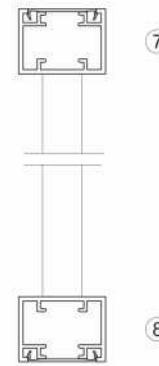
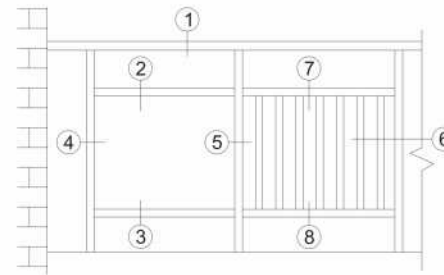
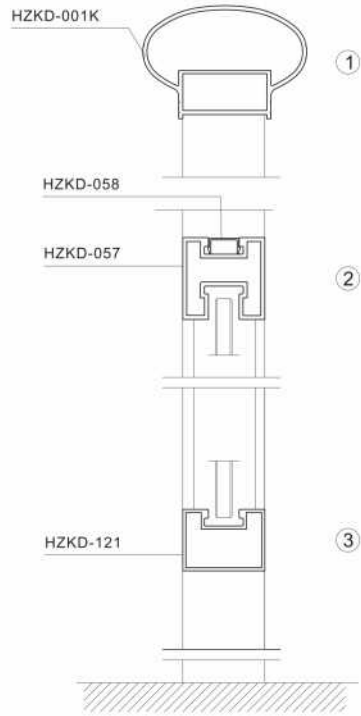
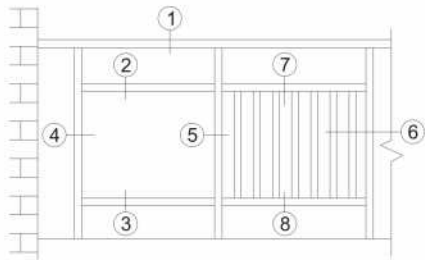



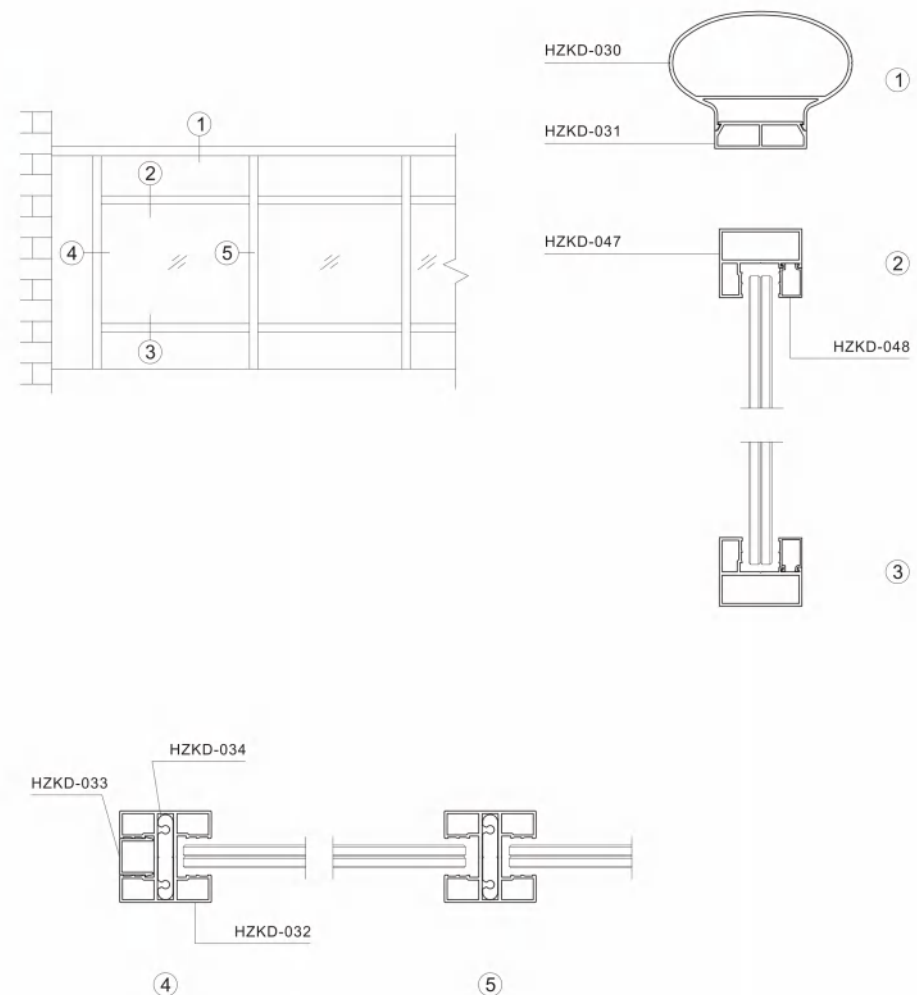

Handrail & Fence

产品编号	产品图例	用途	产品编号	产品图例	用途
HZKD-001D T=2.0mm 1.595kg/m HZKD-001DP T=1.8mm 1.469kg/m HZKD-001F T=1.6mm 1.420kg/m 配: HZKD-004A		扶手	HZKD-002 T=2.0mm 0.986kg/m HZKD-002P T=1.4mm 0.756kg/m 配: HZKD-004A		横杆
HZKD-003 T=2.0mm 0.877kg/m		横杆	HZKD-003A T=2.0mm 0.749kg/m 配: HZKD-004A HZKD-007		横杆
HZKD-004A T=1.2mm 0.112kg/m 配: HZKD-001 HZKD-002 HZKD-003 HZKD-006		盖板	HZKD-005 T=1.2mm 0.380kg/m		栅格
HZKD-006 T=2.0mm 1.031kg/m HZKD-006P T=1.4mm 0.805kg/m 配: HZKD-004A		立柱	HZKD-007 T=1.5mm 0.233kg/m 配: HZKD-003A		玻璃槽
HZKD-019 T=1.2mm 0.243kg/m		栅格	HZKD-036 T=1.2mm 0.404kg/m		栅格
HZKD-121 T=1.5mm 0.660kg/m		横杆	HZKD-057 T=1.9mm 1.134kg/m HZKD-057P T=1.5mm 0.904kg/m 配: HZKD-058 HZKD-059		立柱
HZKD-001 T=2.0mm 2.166kg/m 配: HZKD-004A		扶手	HZKD-001K T=2.0mm 1.500kg/m		扶手
HZKD-059 T=0.9mm 0.119kg/m 配: HZKD-057		封口盖	HZKD-058 T=0.8mm 0.065kg/m 配: HZKD-057		封口盖

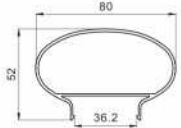
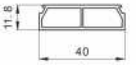
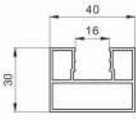
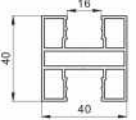
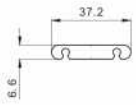

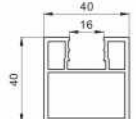
Handrail & Fence

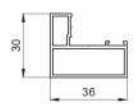
产品编号	产品图例	用途	产品编号	产品图例	用途
HZKD-030 T=1.6mm 0.926kg/m HZKD-030H T=2.0mm 1.137kg/m		扶手面	HZKD-031 T=1.2mm 0.375kg/m		扶手座
HZKD-035 T=1.2mm 0.631kg/m HZKD-035S T=2.0mm 0.890kg/m		边立柱	HZKD-032 T=1.2mm 0.866kg/m HZKD-032H T=2.0mm 1.897kg/m		立柱
HZKD-034 0.561kg/m		连接件	HZKD-033 T=1.1mm 0.129kg/m		盖板
HZKD-035H T=2.0mm 0.998kg/m		立柱	HZKD-048 T=0.8mm 0.094kg/m		压线
HZKD-047 T=1.2mm 0.480kg/m		横杆			

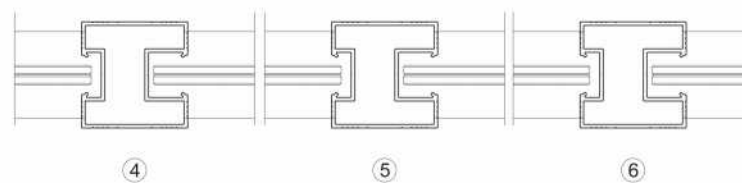
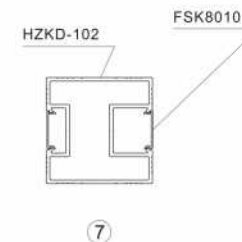
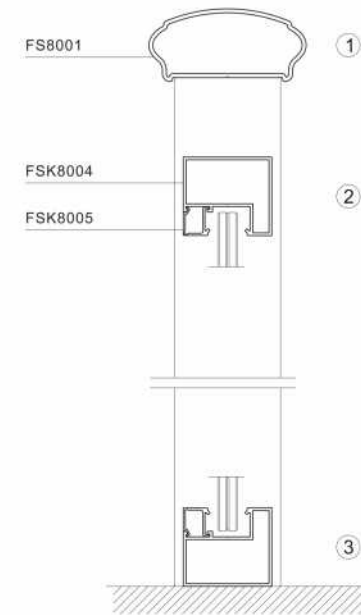
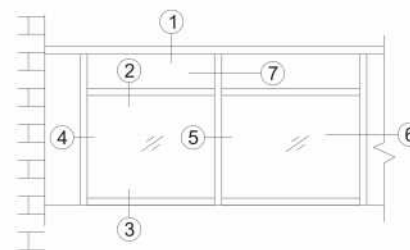





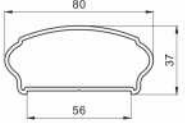
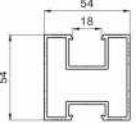
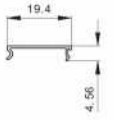
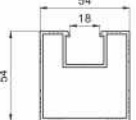
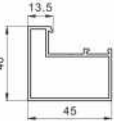
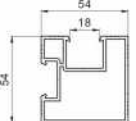
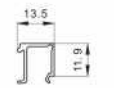

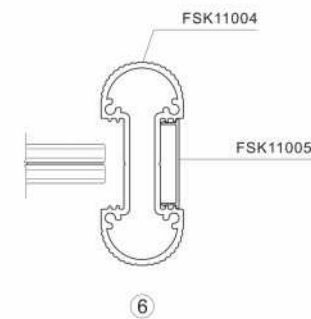
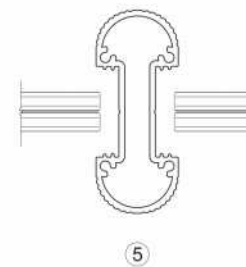
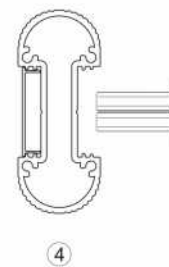
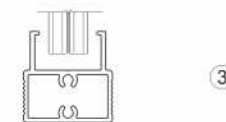
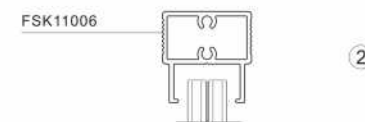
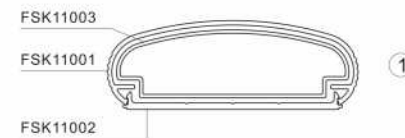
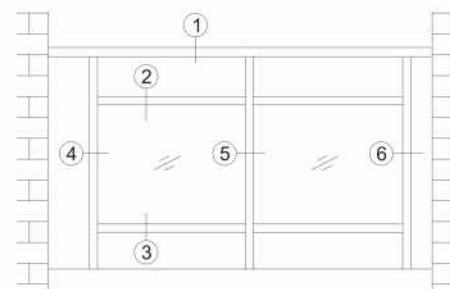
Handrail & Fence

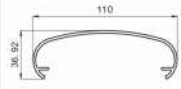
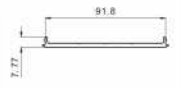
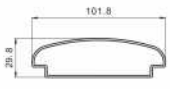
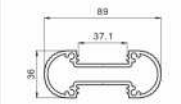
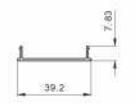
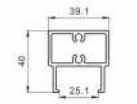
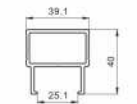
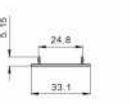
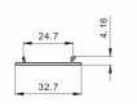
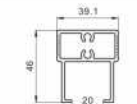
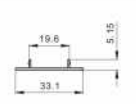
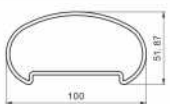
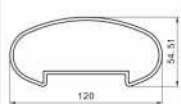
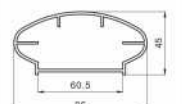
产品编号	产品图例	用途	产品编号	产品图例	用途
FS8001 T=2.0mm 1.064kg/m		扶手	HZKD-102 T=1.8mm 1.365kg/m		立杆
FSK8010 T=0.7mm 0.053kg/m		扣盖	HZKD-104 T=1.7mm 1.166kg/m		立杆
FSK8004 T=1.4mm 0.671kg/m		横杆	HZKD-105 T=1.8mm 1.363kg/m		转角
FSK8005 T=1.0mm 0.128kg/m		压线			

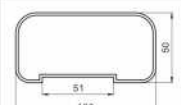

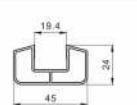
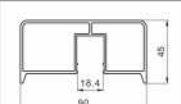
产品编号	产品图例	产品编号	产品图例	产品编号	产品图例
FSK11001 T=2.0mm 0.941kg/m 扶手		FSK11002 T=3.0mm 0.806kg/m 扶手		FSK11003 T=1.5mm 0.963kg/m 扶手	
FSK11004 T=2.5mm 1.875kg/m 立柱		FSK11005 T=1.2mm 0.158kg/m 盖板		FSK11006 T=2.0mm 0.921kg/m 横杆	
FSK11006A T=2.0mm 0.807kg/m 横杆		FSK11007 T=1.0mm 0.108kg/m 盖板		FSK11007A T=1.0mm 0.105kg/m 盖板	
FSK11008 T=2.0mm 1.010kg/m 横杆		FSK11009 T=1.0mm 0.108kg/m 盖板		WD-091 T=2.5mm 1.750kg/m 扶手	
WD-084 T=2.5mm 2.054kg/m 扶手		HZKD-054 T=1.9mm 1.379kg/m 扶手		JS-014 T=2.0mm 1.320kg/m 扶手	
HZKD-116 T=1.9mm 1.450kg/m 扶手		WD-001 T=2.0mm 1.779kg/m 扶手		WD-178 T=1.2mm 0.526kg/m 槽钢	
WD-177 T=1.8mm 1.532kg/m 扶手		HZKD-100 T=2.0mm 2.332kg/m 扶手	